

Start Here

Epson Stylus® CX9400Fax Series

1

Unpack

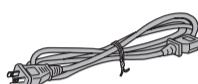
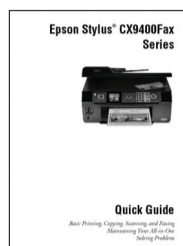
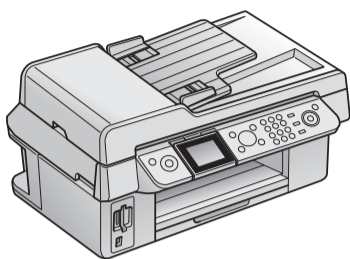

Caution: Do not open ink cartridge packages until you are ready to install the ink. Cartridges are vacuum packed to maintain reliability.

If anything is missing, contact Epson® as described on the back in “Any questions?”.

Remove the tape.

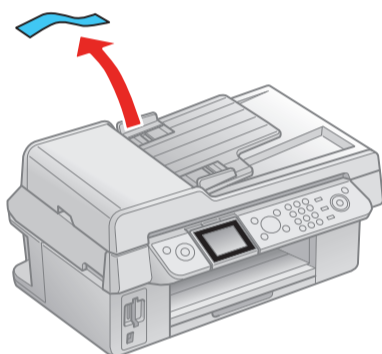

2

Turn on

1 Connect the power cable.

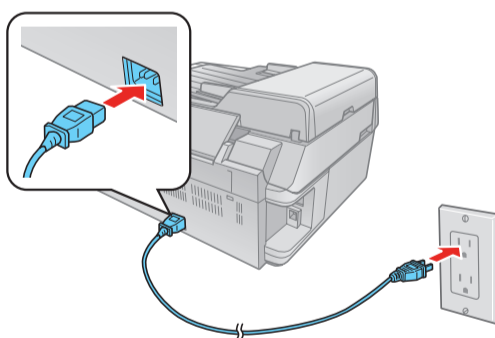

Caution: Do not connect to your computer yet.

2 Press the  On button.

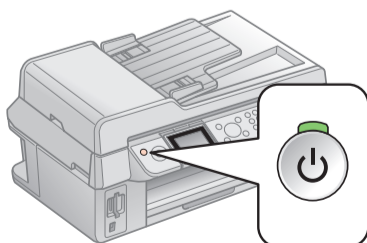

411104700

EPSON®
EXCEED YOUR VISION

3

Make settings

- 1 Select your language and country.

Press ▲ or ▼ to select the desired option.

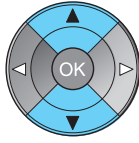

Press **OK** when done.

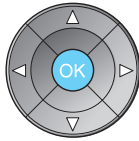

- 2 For the Daylight Time setting, select **Summer** if your region uses Daylight Saving Time and it's currently in effect. (DST is effective from spring through summer.) Otherwise select **Winter** to turn off the setting.

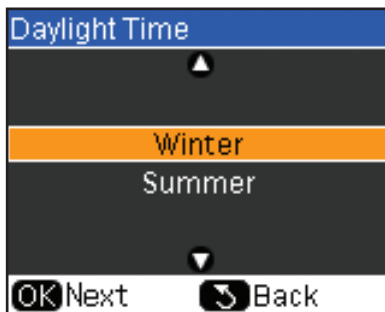

- 3 Press ▲ or ▼ to select the date format, then press ►.

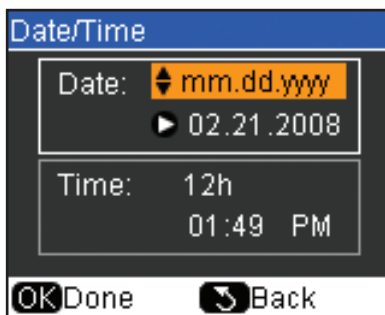

- 4 Use the numeric keypad to set the date.

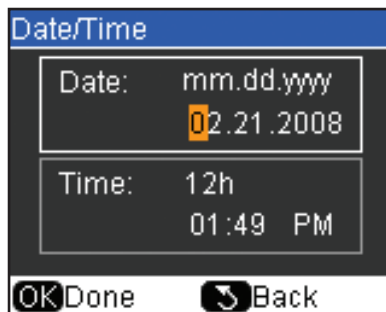
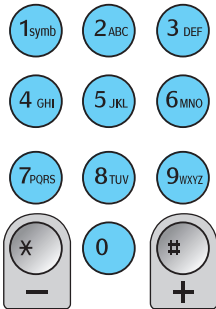

- 5 Press ▲ or ▼ to select the time format, then press ►.

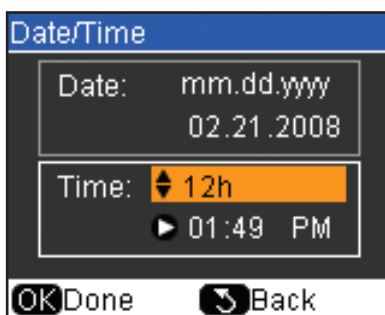

- 6 Use the numeric keypad to set the time.

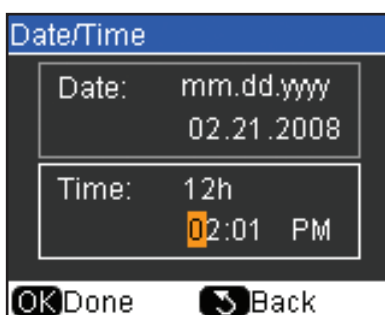

- 7 Press **OK** when done.

4

Install ink cartridges

Note: Don't load paper before installing the ink cartridges.

- 1 Lift up the scanner.
- 2 Open the cartridge cover.

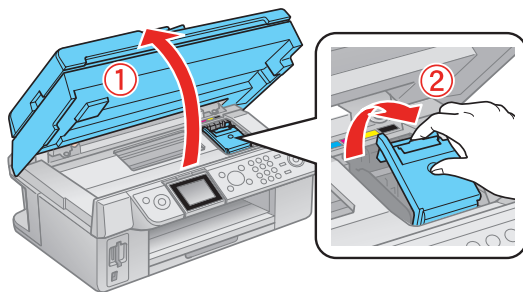

- 3 Shake the ink cartridges, then unpack them.

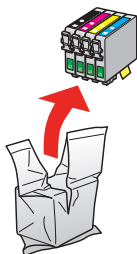

- 4 Remove only the yellow tape from each cartridge.

Caution: Don't remove any other seals from the cartridges.

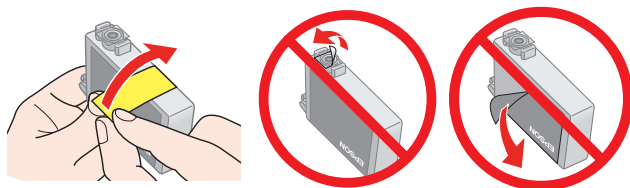

- 5 Insert the cartridges in the holder for each color.

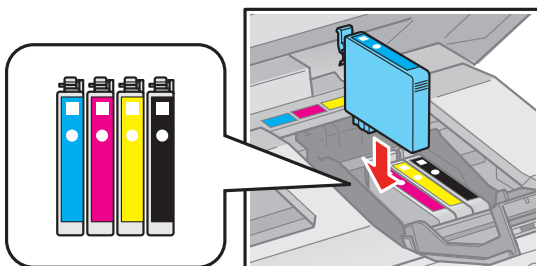

- 6 Press the cartridges down until they click.

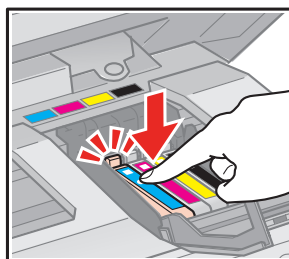

- 7 Close the ink cartridge cover and press it down until it clicks.

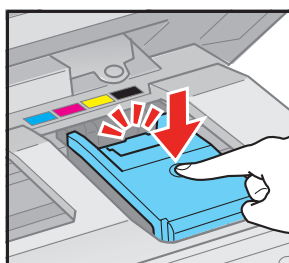

- 8 Close the scanner.

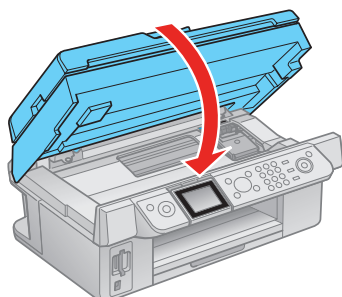

- 9 Press the OK button to charge ink. Charging takes about 2 minutes.

Caution: Don't turn off the CX9400Fax Series while the **On** light is flashing or you'll waste ink.

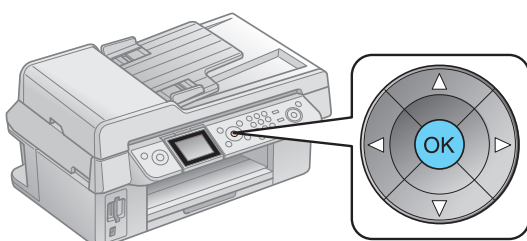

5

Load paper

- 1 Open the paper support and pull up its extension.

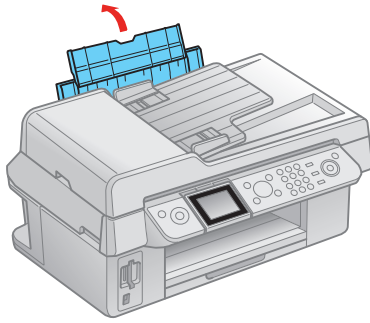

- 2 Open the output tray.

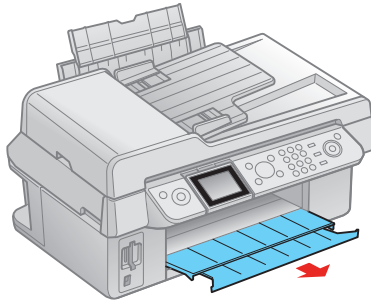

- 3 Slide the edge guide to the left and flip the feeder guard forward.

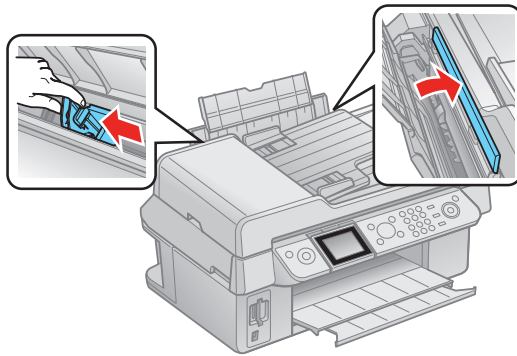

- 4 Load paper against the right edge guide and behind the tab, with the printable side face up.

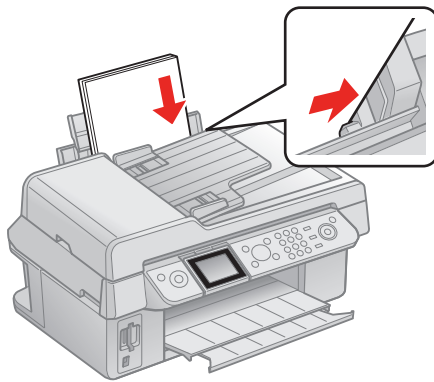

Note: Don't load the paper sideways; always load it short edge first



- 5 Slide the edge guide over.

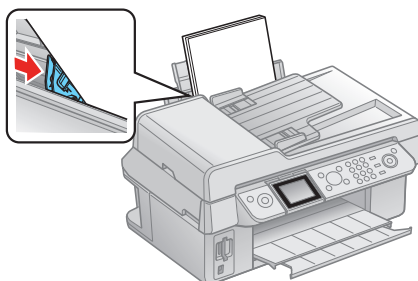

6

Connect the phone cord

To use the CX9400Fax Series for faxing, connect the included phone cord from a telephone wall jack to the **LINE** port on the CX9400Fax Series. To connect a telephone or answering machine, see the *Quick Guide* for instructions.

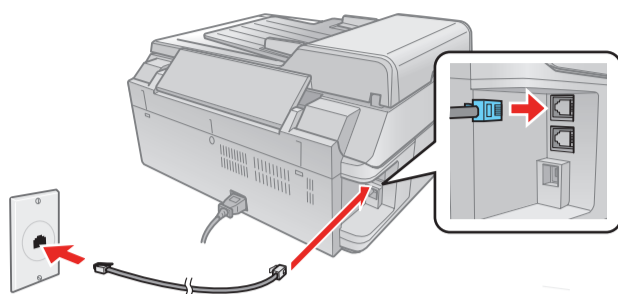

Note: If you're connecting to a DSL phone line, you must use a DSL filter or you won't be able to fax. Contact your DSL provider for the necessary filter.

7

Install software

Your software works with Windows® 2000, XP, XP Professional x64 Edition, Windows Vista™, and Macintosh® OS X 10.2.8, 10.3.9 to 10.4.x or later.

Windows

- 1 Make sure the CX9400Fax Series is **NOT CONNECTED** to your computer.

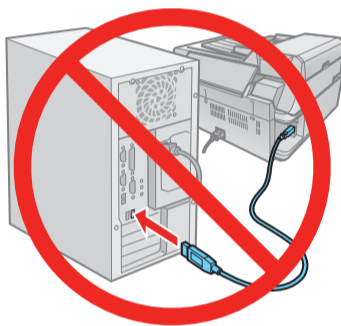

Note: If you see a Found New Hardware screen, click **Cancel** and disconnect the USB cable. You can't install your software that way.

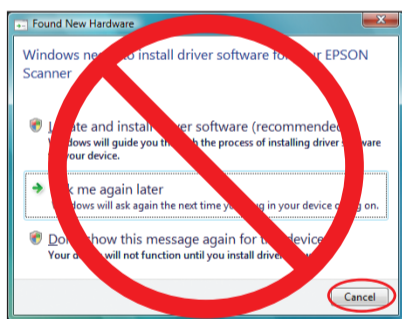

- 2 Insert the CX9400Fax Series software CD.

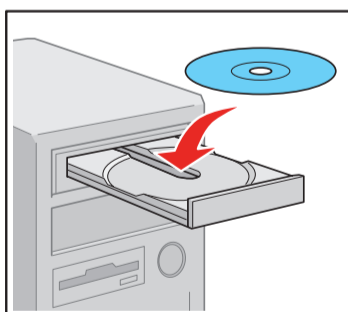

With Windows Vista, if you see the AutoPlay window, click **Run Esetup.exe**. When you see the User Account Control screen, click **Continue**.

- 3 Click **Install** and follow the on-screen instructions.



- 4** When you see this screen, click the first option and then click **Next**, unless the CX9400Fax Series is connected to your computer through an external print server.

If you're using an external print server, click the second option, click **Next**, then skip to step 6.

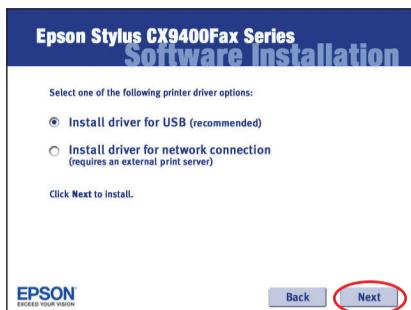

- 5** When prompted, connect the USB cable. Use any open USB port on your computer.

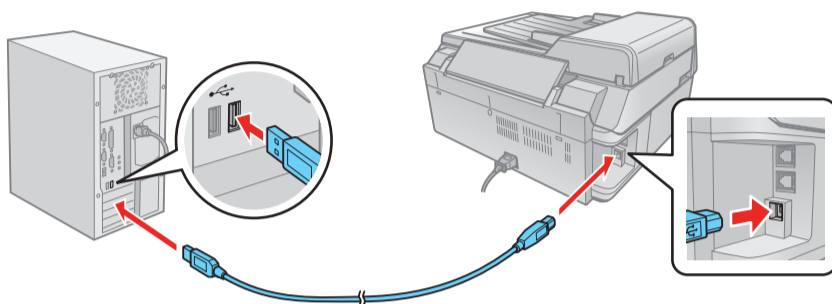

Note: If installation doesn't continue after a moment, make sure you securely connected and turned on the CX9400Fax Series.

- 6** When you're done, remove the CD.

You're ready to print, copy, scan, and fax! See your *Quick Guide* or on-screen *User's Guide*.

Macintosh

- 1** Insert the CX9400Fax Series software CD.

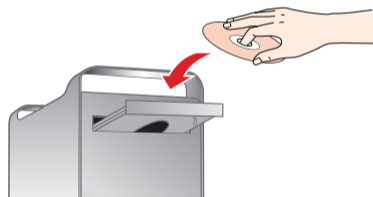

- 2** Double-click the  **Epson** icon.

- 3** Click **Install** and follow the on-screen instructions.

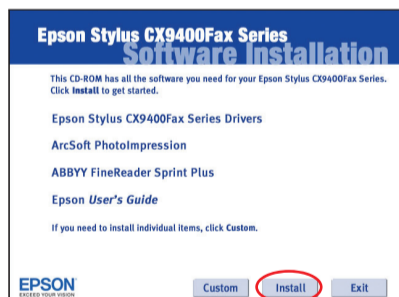

- 4** When prompted, connect the USB cable. Use any open USB port on your computer. Make sure the CX9400Fax Series is securely connected and turned on.

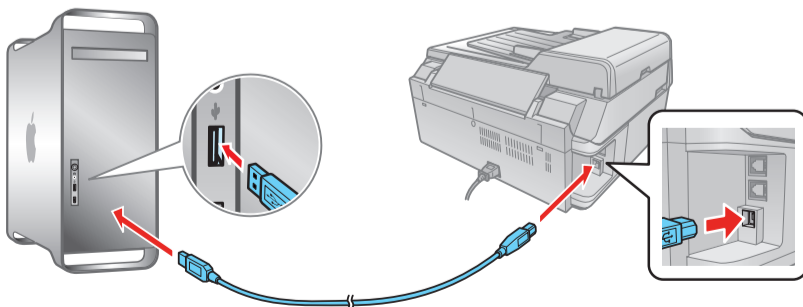

- 5** When you see this screen, click **Open the Printer List**.

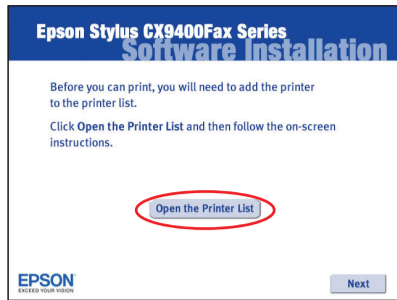

- 6** Follow the steps on the right side of the screen to add the CX9400Fax Series.



- 7** Click **Next** again, if necessary.

- 8** When you're done, eject the CD.

You're ready to print, copy, scan, and fax! See your *Quick Guide* or on-screen *User's Guide*.

Any questions?

Quick Guide

Basic instructions for printing, copying, scanning, and faxing.

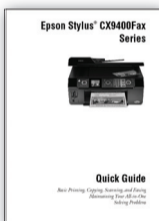

On-screen Epson Information Center

Click the desktop shortcut for easy access to the CX9400Fax Series *User's Guide*, FAQs, online troubleshooting advice, and software downloads. You can also purchase paper and ink.

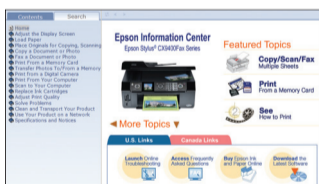

On-screen help with your software

Select **Help** or **?** when you're using your software.

Epson Technical Support

Internet Support

Visit Epson's support website at epson.com/support and select your product for solutions to common problems. You can download drivers and documentation, get FAQs and troubleshooting advice, or e-mail Epson with your questions.

Speak to a Support Representative

Call (562) 276-4382 (U.S.) or (905) 709-3839 (Canada), 6 AM to 6 PM, Pacific Time, Monday through Friday. Toll or long distance charges may apply.

Software Technical Support

ArcSoft PhotoImpression™

(510) 440-9901
www.arcsoft.com

ABBYY® FineReader® Sprint Plus

(510) 226-6717
www.abbyyusa.com
support@abbyyusa.com

Need paper and ink?

Want great results? Simple. Use genuine Epson paper and ink. For the right supplies at the right time, you can purchase them at Epson Supplies CentralSM at www.epson.com/ink3 (U.S. sales) or www.epson.ca (Canadian sales). You can also purchase supplies from an Epson authorized reseller. To find the nearest one, call 800-GO-EPSON (800-463-7766).

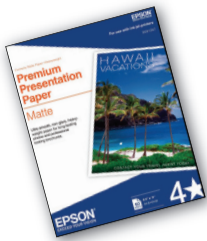

Premium Presentation Paper Matte

Ultra smooth, non-glare, heavy-weight paper for long-lasting photos and professional-looking brochures. See the entire line of Epson photo papers at Epson Supplies Central.

Genuine Epson Inks



Look for the numbers below to find your cartridges. It's as easy as remembering your number!



Black



Magenta



Cyan



Yellow



Try the High Capacity 68 black cartridge available at www.epson.com/highcapacity (U.S. sales) or www.epson.ca (Canadian sales) or at your local reseller.

Epson and Epson Stylus are registered trademarks, Epson Exceed Your Vision and DURABrite are trademarks, and Supplies Central is a service mark of Seiko Epson Corporation.

General Notice: Other product names used herein are for identification purposes only and may be trademarks of their respective owners. Epson disclaims any and all rights in those marks.

© 2007 Epson America, Inc. 6/07

CPD-24115

Cut out the card to the right and keep it with you when purchasing replacement ink cartridges.

Epson® CX9400Fax Series Ink Cartridges



Black



Magenta



Cyan



Yellow



High Capacity 68 black cartridges are also available at www.epson.com/highcapacity (U.S. sales) or www.epson.ca (Canadian sales) or at your local reseller.

